

Revision Notes:

Checked By: -

Approved By: -

Date Released: -

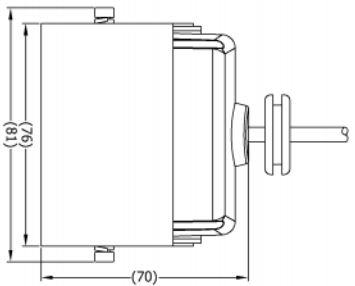

ITEM	STOCK CODE	QTY	DESCRIPTION
1	(4185)	1	VBV-791C-C CAMERA ONLY
2	(3188A)	1	VBV-71XXC-BRT CAMERA BRACKET
3	(3180A)	1	VBV-71XXC-SS CAMERA SUNSHIELD
4	(3191)	1	VBV-71XXC-FIX CAMERA FIXING PACK
5	(3246)	1	VBV-7017(D)CS INSTALLATION GUIDE (NOT SHOWN)

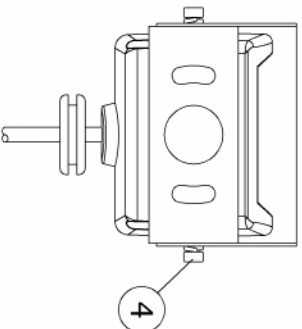
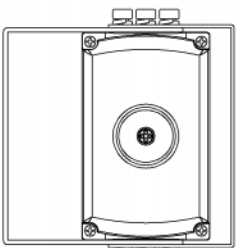
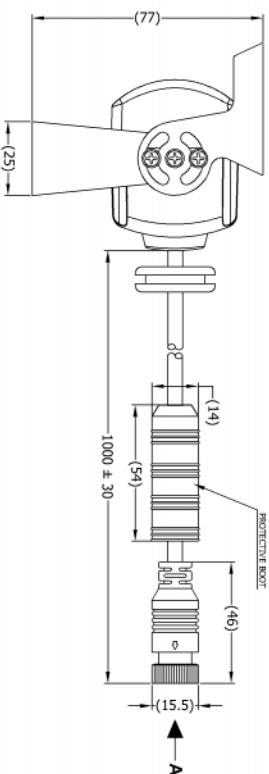
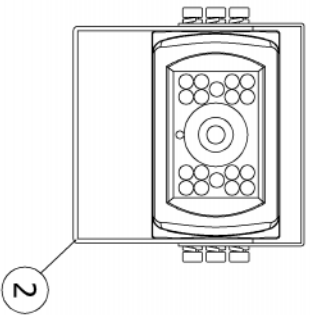
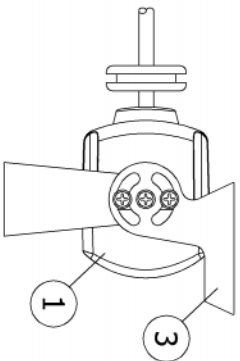
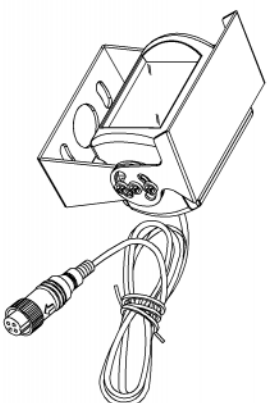

VIEW A



PIN #	WIRE COLOUR	DESCRIPTION
1	RED	+12V
2	BLACK	0V
3	WHITE	NO CONNECTION
4	YELLOW	VIDEO

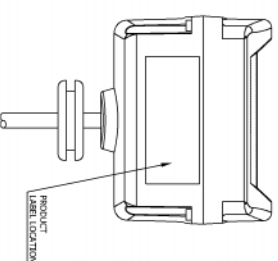

NOTES:

1. REFER TO "PRODUCT SPECIFICATION" FOR MORE DETAILS.
2. REFER TO COMPONENT DRAWINGS FOR COMPONENT DETAILS.
3. FOR SERIAL NUMBER LABEL REFER TO DRAWING NUMBER: BE-001323-XX-10.
4. FOR PRODUCT LABEL REFER TO LATEST REVISION OF DRAWING NUMBER: BE-002050-XX-12.
5. FOR GIFTBOX LABEL REFER TO LATEST REVISION OF DRAWING NUMBER: BE-002051-XX-12.

PROPRIETARY NOTICE

THIS DESIGN AND TECHNICAL INFORMATION APPEARING ON THIS DRAWING IS THE PROPERTY OF BRIGADE ELECTRONICS AND IS DISCLOSED IN CONFIDENCE. IT IS NOT TO BE COPIED, REPRODUCED, REVEALED TO OR EXPLOITED BY OTHERS, EITHER IN WHOLE OR IN PART WITHOUT THE EXPRESS WRITTEN CONSENT OF BRIGADE ELECTRONICS.

BRIGADE
www.brigade-electronics.com

Assembly Pl Approval XINYU HUANG(19/06/12)	Approved by SMATTHEWS	Checked by LBBAR	Drawn by MBUTLER
Angle of Projection Third Angle	Scale N/A	Released 15/06/12	Assembly Ref 12201002051

Status RELEASED	Stock Code A2842A	Released 15/06/12	Assembly Ref 12201002051
VBV-791C		BE-002048-00-12	